



Performance Enhancement of Induced Draft Counter Flow Wet Cooling Tower with Different Types of Modified Shaped Fill Assembly

Suman Dewanjee¹, Sheikh Muhammad Humayun Kabir^{1*}
and Uschuas Dipta Das¹

¹Department of Mechanical Engineering, Chittagong University of Engineering and Technology, Chattogram - 4349, Bangladesh.

Authors' contributions

This work was carried out in collaboration among all authors. All authors read and approved the final manuscript.

Article Information

DOI: 10.9734/JERR/2020/v16i217165

Editor(s):

(1) Dr. Djordje Cica, University of Banja Luka, Bosnia and Herzegovina.

Reviewers:

(1) Hayder Mohammad Jaffal, Al-Mustansiriyah University, Iraq.

(2) Abhijit Dutta, MCKV Institute of Engineering, India.

Complete Peer review History: <http://www.sdiarticle4.com/review-history/59651>

Original Research Article

Received 01 June 2020
Accepted 06 August 2020
Published 27 August 2020

ABSTRACT

This paper presents an experimental analysis of heat transfer using different shaped fills in a counter flow induced draft cooling tower. The main objective is to determine and compare the characteristics of the cooling tower using newly shaped (splash and film) fills and the regular used fills. The newly shaped fills are inverted U-shape cross-sectional splash fill and film fill with ripple plates. The obtained results show that the performance is affected by the type and arrangement of the fills. The modified splash fill has increased the wetted surface area of fill within the same volume compared to regular fills. The film fill with ripple plates has been used such that water from the distribution device ran down on both surfaces of each ripple plate. By the arrangement of ripple plates, cooling loss by premature dropping off of water has been avoided. Performance factors like range, approach, effectiveness, cooling capacity, evaporation loss, percent loss are calculated from collected data for newly shaped fills, and regular shaped fills. It is observed that range, effectiveness, and cooling capacity increases with both newly shaped fills. When ripple plated film fill is used; range, effectiveness, and cooling capacity is found highest among the different shape of fills used in this study. At the same time evaporation loss and percent loss are found lowest for inverted-U shaped splash fill.

*Corresponding author: Email: humayun@cuet.ac.bd

Keywords: Fill; Inverted U-shape; ripple plate; range; effectiveness; cooling capacity.

NOMENCLATURES

Symbol	Meaning	Unit
T_{win}	Water inlet temperature	(°C)
T_{wout}	Water outlet temperature	(°C)
$T_{amb,wb}$	Ambient wet bulb temperature	(°C)
Q	Volume flow rate	L/min
\dot{m}_w	Mass flow rate of water	kg/s
ω	Specific humidity	Kg/Kgda
\dot{m}_a	Mass flow rate of air	kg/s
ρ_a	Air density	kg/m ³
C_p	Specific Heat	(J/kg k)

1. INTRODUCTION

A cooling tower is a vital element of power plants, petrochemical plants, petroleum refineries, semi-conductor plants, natural gas processing plants, food processing plants [1]. The major function of a cooling tower is to discard heat into the environment. Cooling tower works on the principle of heat transfer due to evaporation. The stream of hot water gets cooled due to heat transfer to the air stream in the form of latent heat [2]. Conventional cooling towers of the counter-flow type employ a generally horizontal fill with an air opening below the lower surface of the same. Counter-flow fills with the film type have a relatively good heat transfer coefficient. The air is drawn from below the fill and out of the tower by a fan positioned above the fill [3]. Cooling towers are designed to cool water entering at the top and withdrawn from the bottom and are commonly characterized by the provision of fill slats or bars packed within the tower and designed to break the water stream or large drops. Most towers use fills to facilitate heat transfer by increasing water and air contact. Fills are of two types; i.e. splash or film type. With splash fills, water falls over successive layers of horizontal splash bars, continuously breaking into smaller droplets, while also wetting the fill surface. Plastic splash fill promotes improved heat transfer than the wood splash fill [4]. Film fill consists of thin, closely spaced plastic surfaces over which the water spreads, forming a thin film in contact with the air. These surfaces may be flat, corrugated, honeycombed, or other patterns. The film type of fill is more efficient and provides the same heat transfer in a smaller volume than the splash fill [5]. A recent study showed

that 10-20 % of the overall heat rejected by a large counter-flow wet cooling tower may occur in the rain zone. By reducing the mean drop size in the rain zone, the interfacial surface area between the air and water is increased due to a large number of smaller drops and longer drop resistance times due to increased form drag [6]. The fill slats or splash bars are normally vertically and laterally offset whereby the water droplets are deflected laterally from the fill surface to similar slats or bars positioned below so that maximum water break-up and consequent cooling is effected [7]. The openings improve the efficiency in dispersing the falling water, and forming the fill of plastic material is cost-efficient. In one form of DeFlon, the cross-section is an inverted V-shape, with the legs or plates being approximately at right angles to each other [8]. Generally, diamond-shaped openings are formed throughout each of the legs or plates, with the apex or top ridge being solid to reinforce the bar [9]. Another present invention relates to a cooling tower with corrugated ripple plates, the latter being built in a substantially vertical assembly in wet cooling towers or combined wet-dry cooling towers in counter-flow or cross-flow construction [10].

This study focuses on modification of shape of fill assembly and evaluation of performance characteristics of induced draft counter flow wet cooling tower with this newly shaped fills. In this study, at first, the shape of splash and film fill has been modified to increase the performance. Then an induced draft counter flow cooling tower has been fabricated where four different shaped fills (two modified shaped splash and film fills and two regular shaped splashes and film fills) have been used and conducted the experiment procedure separately. In the end, experimental data with modified shaped (splash and film) fills and regularly shaped (splash and film) fills have been compared to check the performance.

2. METHODS AND MATERIALS

2.1 Proposed Design for Fill

In this experiment, four types of fills have been used. They are regular shaped splash fills (Fig. 1), regular-shaped film fills (Fig. 2), Inverted-U shaped splash fills (Fig. 3), and the film fills with ripple plates (Fig. 4). Inverted-U shaped splash fills and film fills with ripple plates are newly shaped splash and film fills. Inverted U-shape

cross-sectional plates could increase the wetted surface area of fill assembly within essentially in the same volume of space normally occupied by the fill itself [11]. The film with ripple plates could be used such that cooling water from the distribution device would run down on both surfaces of each ripple plate; as a substantially uniform, equal thickness of water film. By the arrangement of the water collector channels on both sides of each ripple plate; a reliable

collection of all the water is possible. The water films had run down the ripple plates up to the collector channels over the entire height of the ripple plate so that a cooling loss also by a premature dropping off of the water would be avoided. Since it is known that water-dropping off in free fall is cooled considerably poorer than a thin water film which runs off on a ripple plate smoothly [12].

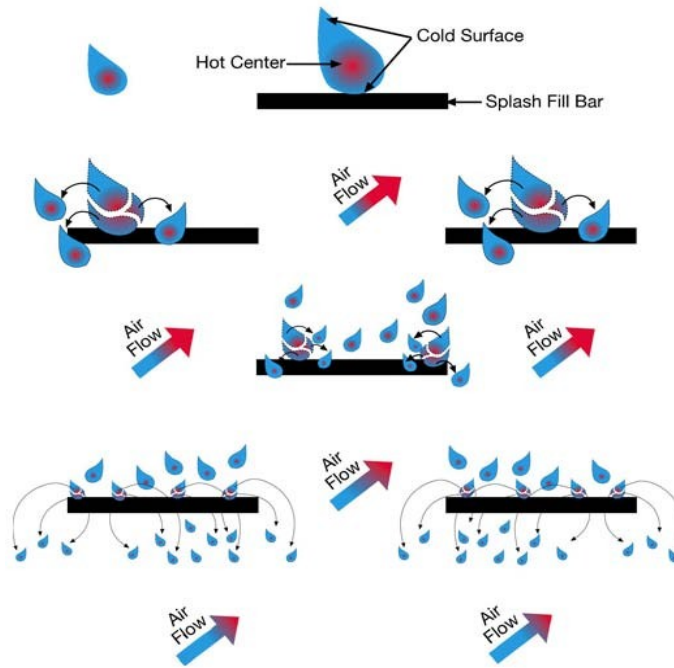

Fig. 1. Regular shaped splash fill [13]

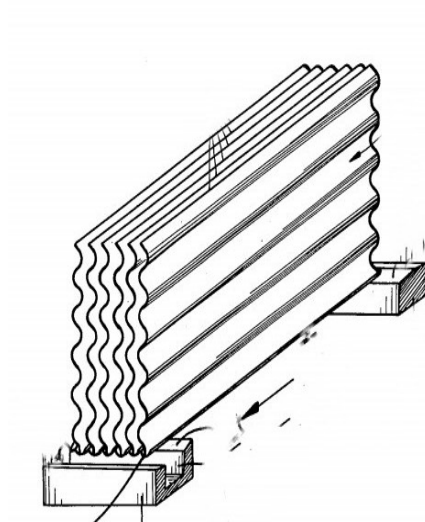

Fig. 2. Regular shaped film fill [12]



Fig. 3. Modified shape of splash fill

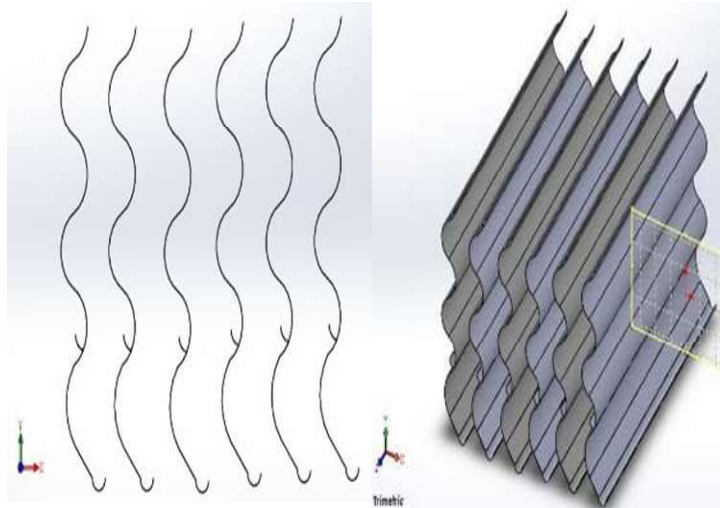

Fig. 4. Modified shape film fill with ripple plates



Fig. 5. Cooling tower with regular-shaped splash fills

2.2 Construction

A rectangular frame made of mild steel has been used as cooling tower. The cooling tower is 35 inch high, and cross sectional area is 16 inch×16 inch. Three sides of the rectangular box are made of mild steel where one side is made of transparent acrylic to make inside visible. An axial fan has been added on the top of the tower with the help of nut and bolts to make the water cool. A circular cross-sectional

pipe of rotating assembly has been used below the fan as a sprayer, which contains a lot of pores under it. From the sprayer, a pipe is connected to a rotameter to measure the flow rate. A centrifugal pump is connected to the lower side of it to allow the cold water to go into a cold water basin i.e. a bucket. Four types of fills have been used in this experimental setup and conducted an experiment procedure separately as in Fig. 5 to Fig. 8. At first regular-shaped splash, fills have been used. The vertical

distance between two rows of fill packing is 2 inch and in each row there is 5 regular shaped bars. Then regular- shaped film fills have been used; the vertical fill arrangement is 2 inch apart from one another. After that Inverted-U shaped splash fills have been used with the

same dimension of regular shaped splash fills. Finally, film fills with ripple plates have been used; the ripple plate have been used in both sides of each film fill. The volume of these four types fill arrangements have been kept same.



Fig. 6. Cooling tower with regular-shaped film fills



Fig. 7. Cooling tower with inverted u-shaped splash fills



Fig. 8. Cooling tower with film fills with ripple plates

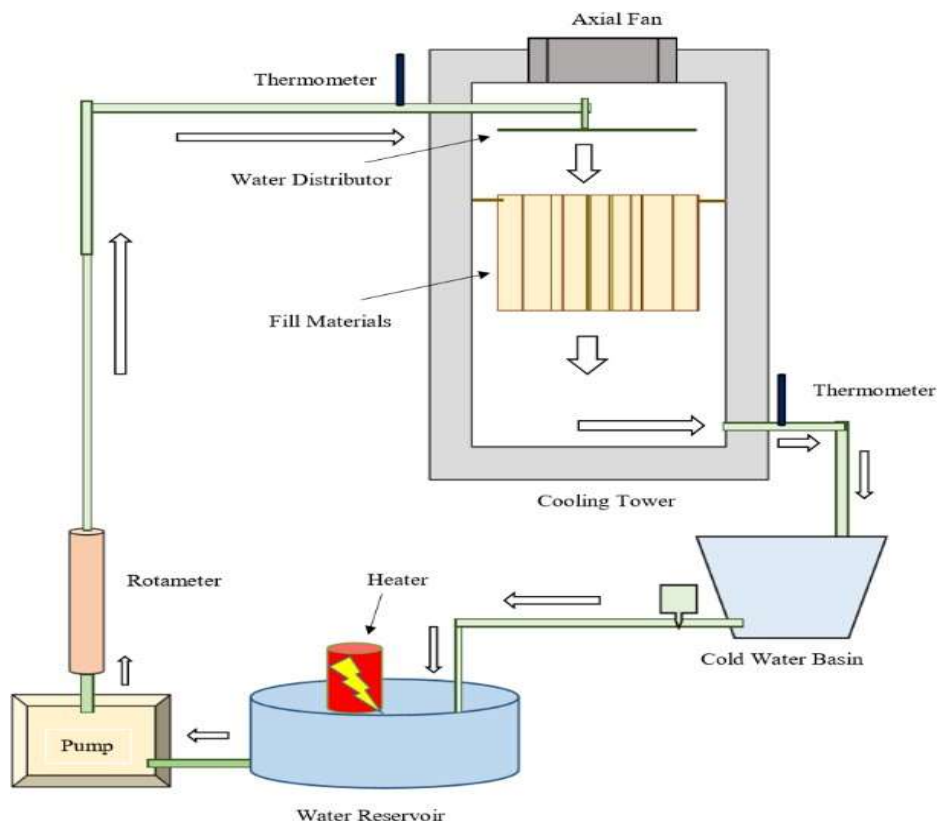

Fig. 9. Schematic diagram of the experimental setup

2.3 Experimental Procedure

Fig. 9 illustrates the experimental procedure conducted in this study. At first, water is heated in a reservoir using the heater. When the temperature of water in the reservoir reaches the desired temperature then the fan and pump are started. Hot water is pumped from a storage tank to the tower. Water distributors are used to distributing the water uniformly over the packing. An axial fan is fixed on the top of the tower to extract the air from the bottom of the tower. The pump is used to circulate the hot water over the packing in a counter manner to the airflow. Before each experiment, the main water is heated by a heater and stored in the tank. The water is allowed to re-circulate through the heater to obtain the desired water temperature.

The water flow rate is determined from the rotameter installed in the supply line. The flow regulating valve is adjusted to measure the water flow rate. The air dry bulb and wet bulb temperatures are again measured below the water extraction troughs. These temperatures differ from the temperatures measured upstream of the nozzles due to the influence of the fan. The temperature measurements are taken after allowing enough time for steady-state readings. The inlet air and water temperatures are measured before and during the experiment. Four sets of experiments are performed for the different layout of packing fills. In this work, the main objective is to determine and compare the characteristics (or performance) of the cooling tower with modified fill materials. The performance of a cooling tower depends on the range of cooling, the approach of the cold water to the wet-bulb temperature of the air.

2.4 Calculation Method

The governing equation used to measure the performance characteristics of cooling tower are given below: [14]

$$\text{Range} = T_{\text{win}} - T_{\text{wout}} \quad (1)$$

$$\text{Approach} = T_{\text{wout}} - T_{\text{amb,wb}} \quad (2)$$

$$\text{Effectiveness} = \frac{\text{Range}}{\text{Range} + \text{Approach}} \quad (3)$$

$$\text{Mass flow rate of water, } \dot{m}_w = \frac{Q(\frac{L}{\text{min}})}{60 \times 1000} \times 1000 \text{ kg/s} \quad (4)$$

$$\text{Cooling capacity} = \dot{m}_w C_p (T_{\text{win}} - T_{\text{wout}}) \quad (5)$$

$$\text{Mass flow rate of air, } \dot{m}_a = \rho_a V_a A \quad (6)$$

$$\text{Evaporation loss} = \dot{m}_a (\omega_{\text{out}} - \omega_{\text{in}}) \quad (7)$$

$$\text{Percent loss} = \frac{\text{Evaporation loss}}{\text{Mass flow rate of inlet water}} \quad (8)$$

3. EXPERIMENTAL DATA

The experimental data shows the air velocity is 7.3 m/s which is obtained from the anemometer. The water flow rate is obtained by rotameter which is 8 liter/min. The inlet water temperature, outlet water temperature, inlet air dry bulb temperature, outlet air dry bulb temperature, wet bulb temperature is calculated from a digital temperature sensor in °c. The inlet air dry bulb temperature is 31.5°C, the outlet air dry bulb temperature is 30.5°C and the wet-bulb temperature is 28.8°C. The relative humidity is obtained from a psychometric chart with respect to inlet and outlet air dry bulb temperature and wet bulb temperature. So we have calculated inlet and outlet air relative humidity from the sensor in %. The experimental data and calculated characteristics of counter flow cooling tower using different fills are tabulated in Table 1 to Table 4.

4. RESULTS AND DISCUSSION

The calculated characteristics of cooling tower using different fills are tabulated in Table 5 to Table 8. The comparison of performance characteristics using different fills are tabulated in Table 9.

In the graph of Fig. 10 to Fig. 13, the water inlet temperature is measured from 40°C to 75°C. The performance characteristics i.e. Range, effectiveness, cooling capacity, evaporation loss, percent loss are compared graphically for each type of fills. From these characteristics chart, it is observed that range, effectiveness, and cooling capacity increases with both newly shaped fills. When ripple plated film fill is used; range, effectiveness, and cooling capacity is found highest among the different shape of fills used. For water flow rate 8 liter/min and air velocity 7.3 m/s, it is evident from the experiment that the

Table 1. Experimental data of regular shaped splash fill

Obs no.	Inlet water temp T_{win} (°C)	Outlet water temp T_{wout} (°C)	Inlet Air RH (%)	Outlet Air RH (%)	ω_{in} (kgw/kgda)	ω_{out} (kgw/kgda)
1	40.1	34.5	83	90	0.0242	0.0247
2	44.8	38.5	83	89	0.0242	0.0246
3	50.2	44.1	83	89	0.0242	0.0206
4	54.4	48.6	82	87	0.0241	0.0245
5	60.3	53.8	82	89	0.0243	0.0248
6	65.6	58.7	82	88	0.0243	0.0247
7	69.4	62.2	82	88	0.0243	0.0247
8	75.5	68.4	82	88	0.0243	0.0247
Av	57.53	51.1	82.375	88.5	0.0242	0.0246

Table 2. Experimental data of Inverted-U shaped splash fill

Obs no.	Inlet water temp T_{win} (°C)	Outlet water temp T_{wout} (°C)	Inlet Air RH (%)	Outlet Air RH (%)	ω_{in} (kgw/kgda)	ω_{out} (kgw/kgda)
1	40.4	34.3	84	88	0.0243	0.0246
2	45.2	38.8	84	88	0.0243	0.0246
3	50.1	44.4	82	88	0.0242	0.0246
4	55.3	48.4	82	88	0.0243	0.0247
5	60.2	53.5	83	88	0.0244	0.0247
6	65.8	58.7	82	88	0.0243	0.0247
7	70.4	63	82	87	0.0243	0.0246
8	75.9	68.3	81	87	0.0243	0.0246
Av	57.91	51.175	82.5	87.75	0.0242	0.0246

Table 3. Experimental data of regular shaped film fill

Obs no.	Inlet water temp T_{win} (°C)	Outlet water temp T_{wout} (°C)	Inlet Air RH (%)	Outlet Air RH (%)	ω_{in} (kgw/kgda)	ω_{out} (kgw/kgda)
1	40.3	32.7	87	93	0.0229	0.0233
2	45.5	38.1	87	93	0.0229	0.0233
3	50.8	42.7	87	93	0.023	0.0234
4	56.1	47.5	87	93	0.0229	0.0233
5	61.3	52.2	87	93	0.0229	0.0233
6	65.4	56.6	87	93	0.0231	0.0234
7	70.1	60.8	87	93	0.0231	0.0234
8	75.7	66.5	87	92	0.023	0.0234
Av	58.15	49.63	87	92.8	0.0229	0.0233

Table 4. Experimental data of film fill with ripple plate

Obs no.	Inlet water temp T_{win} (°C)	Outlet water temp T_{wout} (°C)	Inlet Air RH (%)	Outlet Air RH (%)	ω_{in} (kgw/kgda)	ω_{out} (kgw/kgda)
1	40.5	32.1	88	94	0.0246	0.025
2	45.2	36.5	88	94	0.0246	0.025
3	50.7	41.6	87	93	0.0244	0.0247
4	55.6	46	87	93	0.0243	0.0247
5	60.3	50.2	86	92	0.0243	0.0247
6	65.6	54.4	88	94	0.0247	0.0251
7	70.3	58	87	93	0.0246	0.025
8	75.7	63.2	87	92	0.0246	0.025
Av	57.98	47.75	87.25	93.125	0.0245	0.0249

Table 5. Calculated characteristics of regular shaped splash fill

Obs no	Range (°C)	Approach (°C)	Effectiveness (%)	Cooling Capacity (KW)	Percent loss (%)	Evaporation loss (kg/s)
1	5.6	5.7	49.55	3.136	0.19	0.00026
2	6.3	9.7	39.37	3.528	0.161	0.000215
3	6.1	15.3	28.50	3.416	0.16	0.000215
4	5.8	19.8	22.65	3.248	0.16	0.000215
5	6.5	24.9	20.7	3.640	0.20	0.00027
6	6.9	29.8	18.80	3.864	0.16	0.000215
7	7.2	33.3	17.77	4.032	0.16	0.000215
8	7.1	39.5	15.23	3.976	0.16	0.000215
Av	6.4	22.25	26.55	3.605	0.1695	0.0002

Table 6. Calculated characteristics of Inverted-U shaped splash fill

Obs no	Range (°C)	Approach (°C)	Effectiveness (%)	Cooling Capacity (KW)	Percent loss (%)	Evaporation loss (kg/s)
1	6.1	5.5	52.58	3.42	0.12	0.000161
2	6.4	10	39.024	3.58	0.12	0.000161
3	5.7	15.6	26.76	3.19	0.16	0.000215
4	6.9	19.5	26.13	3.86	0.16	0.000215
5	6.7	24.6	21.40	3.75	0.12	0.000161
6	7.1	29.8	19.24	3.98	0.12	0.000161
7	7.4	34.1	18.22	4.14	0.16	0.000215
8	7.6	39.4	16.17	4.25	0.12	0.000161
Av	6.735	22.31	27.44	3.77	0.135	0.000145

Table 7. Calculated characteristics of regular shaped film fill

Obs no	Range (°C)	Approach (°C)	Effectiveness (%)	Cooling Capacity (KW)	Percent loss (%)	Evaporation loss (kg/s)
1	7.6	5	60.31	4.256	0.161	0.000215
2	7.4	10.4	41.57	4.144	0.161	0.000215
3	8.1	14.9	35.21	4.536	0.161	0.000215
4	8.6	19.8	30.28	4.816	0.161	0.000215
5	9.1	24.5	27.08	5.096	0.161	0.000215
6	8.8	28.8	23.40	4.980	0.12	0.000161
7	9.3	33	21.98	5.208	0.12	0.000161
8	9.2	38.7	19.20	5.152	0.161	0.000215
Av	8.51	21.88	32.37	4.767	0.15	0.0002

Table 8. Calculated characteristics of film fill with rippleplate

Obs no	Range (°C)	Approach (°C)	Effectiveness (%)	Cooling Capacity (KW)	Percent loss (%)	Evaporation loss (kg/s)
1	8.4	3.3	71.79	4.704	0.161	0.000215
2	8.7	7.7	53.04	4.872	0.161	0.000215
3	9.1	12.9	41.36	5.096	0.12	0.000161
4	9.6	17.3	35.68	5.376	0.161	0.000215
5	10.1	21.5	31.96	5.656	0.161	0.000215
6	11.2	25.5	30.51	6.272	0.161	0.000215
7	12.3	29.1	29.71	6.888	0.161	0.000215
8	12.5	34.3	26.71	7.0	0.161	0.000215
Av	10.23	18.95	40.095	5.733	0.155	0.0002

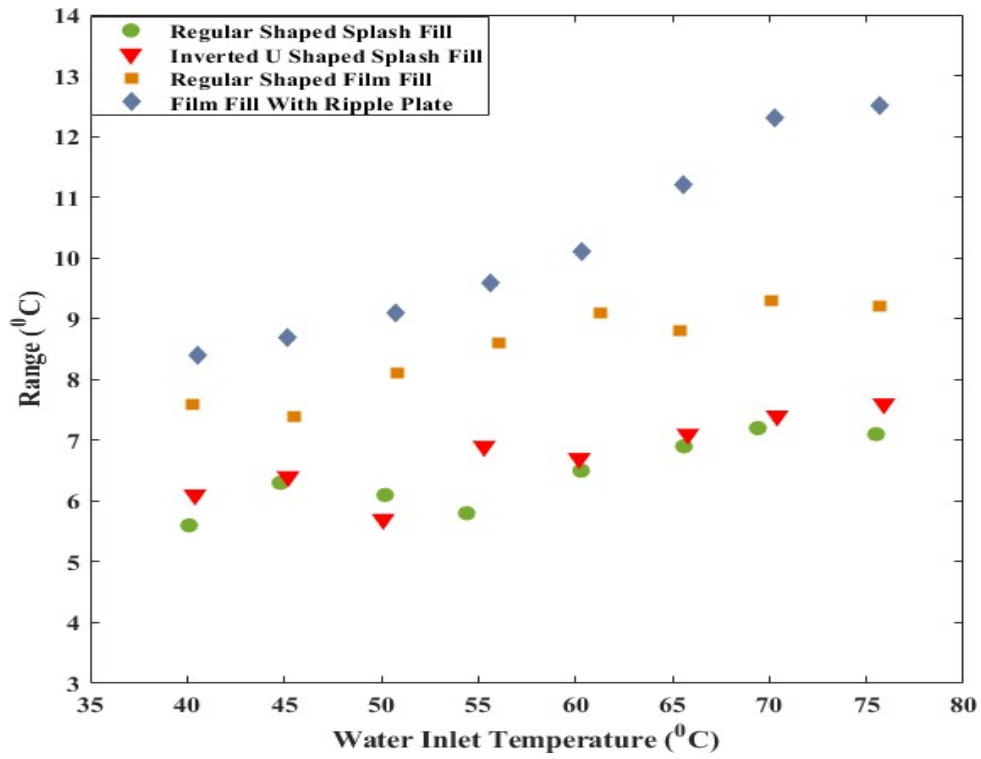

Fig. 10. Range vs water inlet temperature

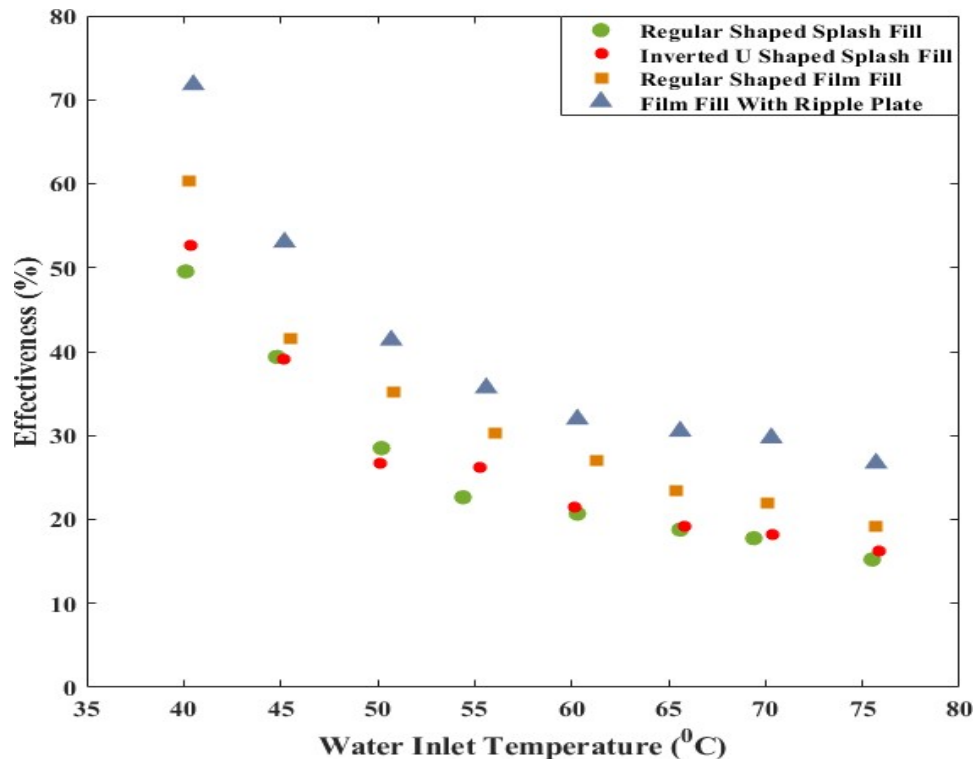

Fig. 11. Effectiveness vs water inlet temperature

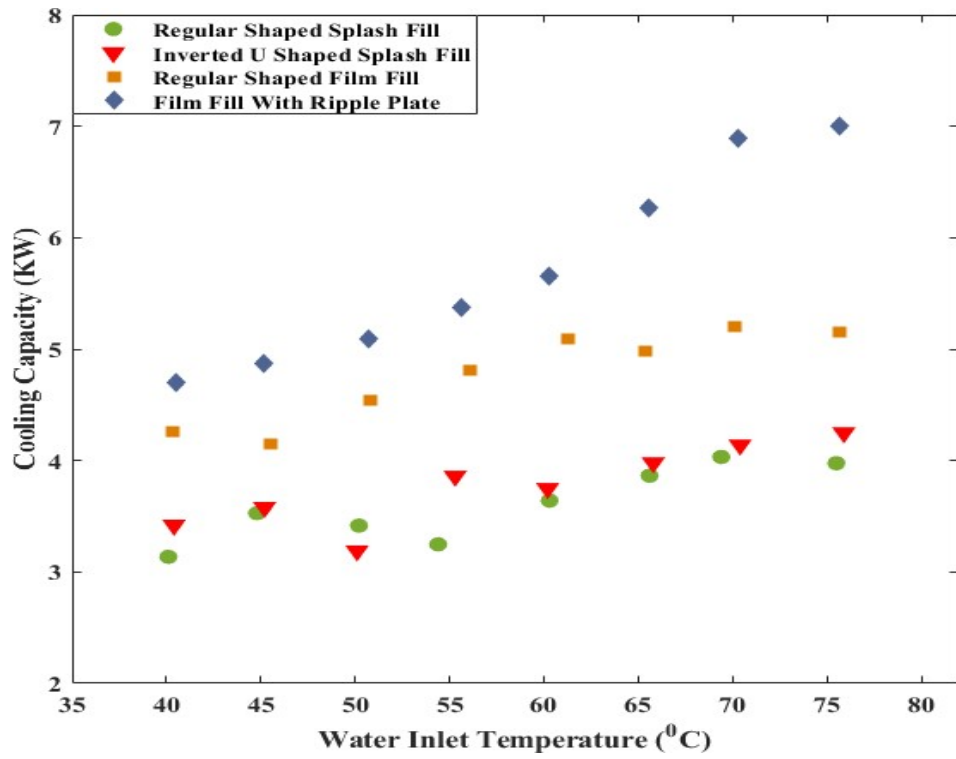

Fig. 12. Cooling capacity vs water inlet temperature

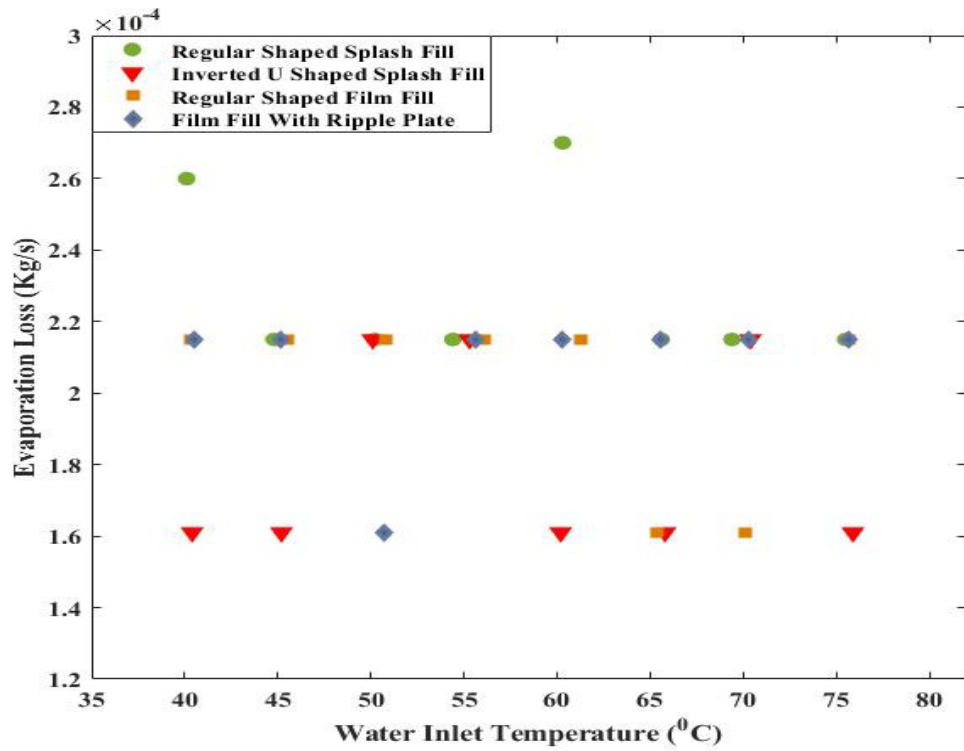

Fig. 13. Evaporation loss vs water inlet temperature

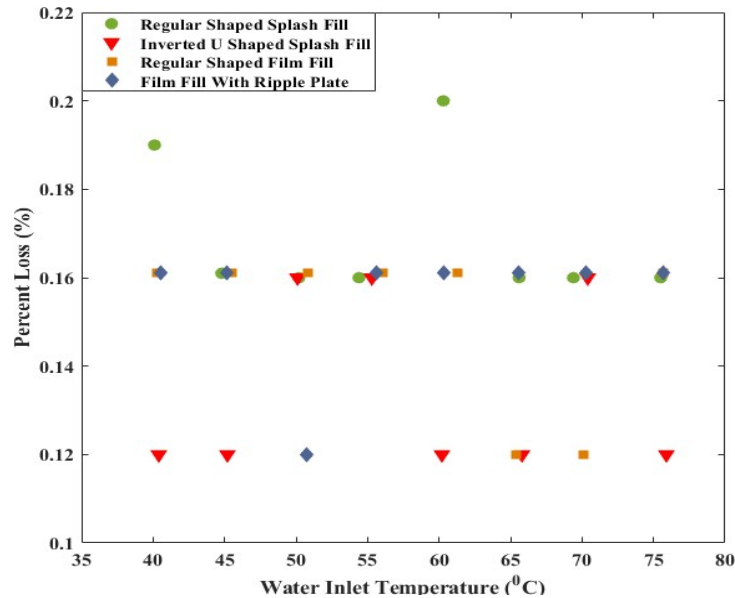

Fig. 14. Percent loss vs water inlet temperature

Table 9. Comparison of the experimental data of different fills

Types of fills	Range (°C)	Effectiveness (%)	Cooling capacity(KW)	Evaporation loss (kg/s)	Percent loss (%)
Regular shaped splash fill	6.4	26.55	3.605	0.000275	0.1695
Inverted U shaped splash fill	6.735	27.44	3.77	0.000145	0.135
Regular shaped film fill	8.51	32.37	4.767	0.000201	0.150
Film fill with ripple plate	10.23	40.095	5.733	0.000208	0.155

range of ripple plated film fill increases approximately 60% compared to the regular shaped fill setup. Effectiveness also increases approximately 51% (for ripple plated film fill) compared to regular shaped fill. The cooling capacity of ripple plated film fill setup also increases by about 59%. Evaporation loss and percent loss is found lowest for inverted-U shaped splash fill which is accordingly decreased about 52% and 79% compared to regular shaped splash fill.

5. CONCLUSION

The experiments were conducted to investigate the performance and characteristics of the cooling tower with new shaped (splash and film) fills and the regularly used fills. The study has been done to increase the efficiency of the cooling tower by enabling more volume of air to pass through the tower and hence more heat will be dissipated. It was found that the factors affecting the heat transfer are a range of cooling, the approach of the cold water to the wet-bulb

temperature of the air. From the experiment, it is observed that the newly designed fill has shown higher performance than the regular type. The studies on cooling towers have been carried out on various aspects of cooling towers aim at optimizing the operation. Inverted u- shape cross-sectional plate increased the wetted surface area of fill assembly within the same volume of space normally occupied by the fill itself. The film with ripple plates have been used such that cooling water from distribution device would run down on both surface of each ripple plate; as uniform, the equal thickness of water film. By the arrangement of the water collector channels on both sides of each ripple plate; a reliable collection of all the water is possible. The water films had run down the ripple plates up to the collector channels over the entire height of the ripple plate so that a cooling loss also by a premature dropping off of the water has been avoided. Since it is known that water-dropping off in free fall is cooled considerably poorer than a thin water film which runs off on a ripple plate smoothly. It did not increase the pressure drop

through the fill area. The zigzag water flow pattern has made the water movement slow down and a longer time of water exposure to air is achieved. Compared to regular used fills; range, effectiveness, and cooling capacity are higher for inverted u-shape splash fill and for ripple plated film fills. At the same time evaporation loss and percent loss is found lowest for inverted u-shape splash fill. Thermal efficiency and the improved operational performance had been met with minimal effects on material and installation costs.

COMPETING INTERESTS

Authors have declared that no competing interests exist.

REFERENCES

1. Pushpa BS, Vasant Vaze PT, Nimbalkar. Performance evaluation of cooling tower in thermal power plant - A case study of rtps, Karnataka. International Journal Of Engineering And Advanced Technology. 2014;4(2)110-114,.
2. Guo Q, Qi X, Sun P, Guo P. New explicit analytical solutions of equations for heat and mass transfer in a cooling tower energy system. Advances in Mechanical Engineering. 2019;11(12).
3. Shahali P, Rahmati M, Alavi SR, Sedaghat A. Experimental study on improving operating conditions of wet cooling towers using various rib numbers of packing. International Journal of Refrigeration. 2016;65:80–91.
4. Ronak Shah, Trupti Rathod. Thermal design of cooling tower. International Journal of Advanced Engineering Research and Studies. 2012;1:26-29.
5. Gharagheizi F, Hayati R, Fatemi S, Experimental study on the performance of mechanical cooling tower with two types of film packing. Energy Conversion and Management. 2007;48(1):277–280.
6. Zhou Y, Wang K, Gao M, Dang Z, He S, Sun F. Experimental study on the drag characteristic and thermal performance of non-uniform fillings for wet cooling towers under crosswind conditions. Applied Thermal Engineering. 2018;140:398–405.
7. Singh K, Das R. An experimental and multi-objective optimization study of a forced draft cooling tower with different fills. Energy Conversion and Management. 2016;111:417– 430.
8. Dutta A, Das AK, Chakrabarti S. Study on the effect of cooling water temperature rise on loss factor and efficiency of a condenser for a 210 MW thermal power unit. International Journal of Emerging Technology and Advanced Engineering; 2016.
9. Ramkumar R, Ragupathy A. Thermal performance of forced draft counter flow wet cooling tower with expanded wire mesh packing. International Journal on “Technical and Physical Problems of Engineering”. 2011;3(1)19-24.
10. Grobbelaar PJ, Reuter HCR, Bertrand TP. Performance characteristics of a trickle fill in cross- and counter-flow configuration in a wet-cooling tower. In Applied Thermal Engineering. 2013;50(1): 475–484,.
11. Shepherd CE. Fill assembly for cooling tower. United States Patent. 1990;4: 915,877.
12. Henning H, Siegfried V. Cooling tower with ripple plates. United States Patent. 1980; 4:218,408.
13. Gao M, Zhang L, Wang NN, Shi YT, Sun FZ. Influence of non-uniform layout fillings on thermal performance for wet cooling tower. Applied Thermal Engineering. 2016; 93:549–555..
14. Hensley JC, ed. Cooling tower fundamentals, 2nd edition; the marley cooling tower Co. (now part of SPX Cooling Technologies, Overland Park, Kansas);1985.

© 2020 Dewanjee et al.; This is an Open Access article distributed under the terms of the Creative Commons Attribution License (<http://creativecommons.org/licenses/by/4.0>), which permits unrestricted use, distribution, and reproduction in any medium, provided the original work is properly cited.

Peer-review history:
The peer review history for this paper can be accessed here:
<http://www.sdiarticle4.com/review-history/59651>